

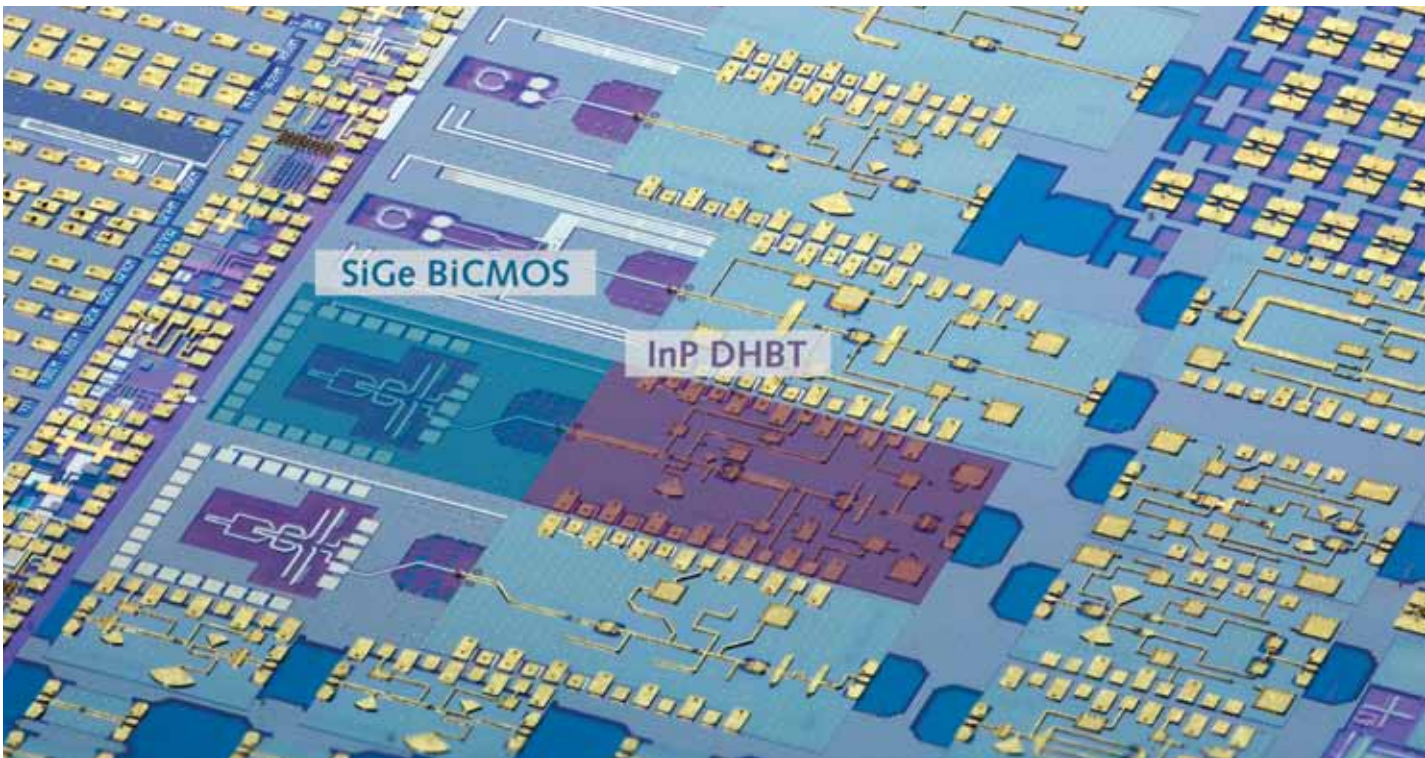

Leibniz
Ferdinand
Braun
Institut

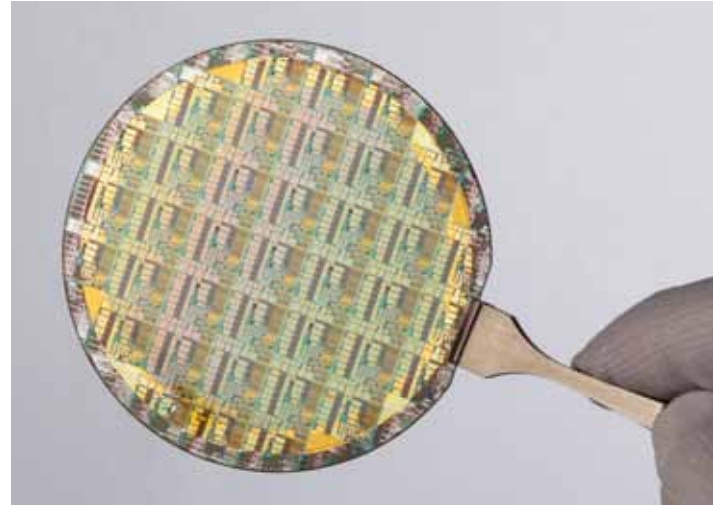
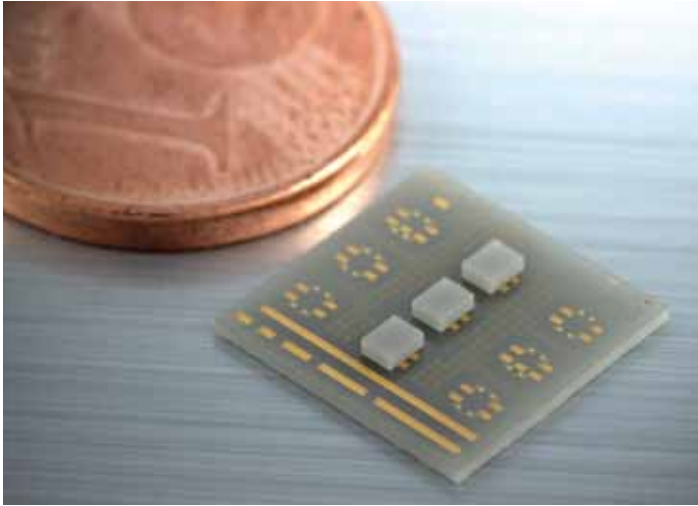

InP HBT Technology

for Terahertz Applications

Entire Value Chain for Terahertz Electronics

FBH develops electronic components for terahertz (THz) applications such as high-resolution radar, wideband wireless communications, and analytical sensing. These devices are based on FBH's in-house indium phosphide heterobipolar transistor (InP HBT) technology, while dedicated THz detection devices rely on FBH's GaN HEMT technology. The institute is a competence center for the entire THz electronics development chain

including circuit design, wafer processing, chip mounting, high frequency measurement, and modeling. This way, FBH both advances the field itself and supports industry in developing applications that require THz electronics. These activities aim at filling the gap between the ongoing fundamental research and application-driven demand for a mature and stable technology along with a reliable support chain.

Transferred Substrate InP HBT Fabrication Process

The close proximity of the semiconductor substrate makes it an integral part of the transistor – worsening the device's high frequency properties through dielectric losses and fringing capacitances. In FBH's process, the InP semiconductor substrate is removed following an adhesive BCB (benzocyclobutene) wafer bonding process to a host substrate. The BCB layer separates the active device layers from the substrate thus reducing parasitic capacitances. FBH's InP HBTs with $0.8 \times 6 \mu\text{m}^2$ emitter area achieve cut-off frequencies f_t and f_{max} of 350 GHz at 20 mA collector current and 4 V_{CEO} breakdown voltage. Newly developed $0.5 \mu\text{m}$ transistors reach $f_{\text{max}} = 450 \text{ GHz}$.

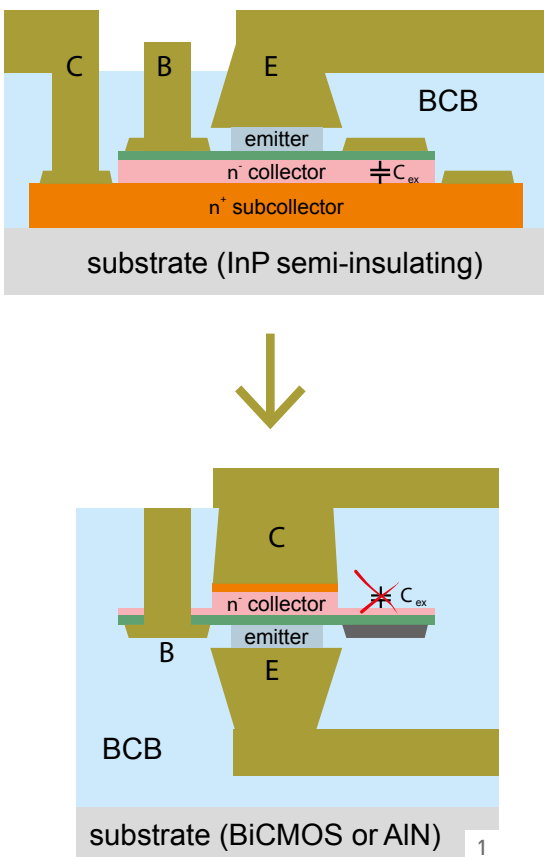

1 traditional triple-mesa InP HBT (top)
FBH transferred substrate InP HBT (bottom)

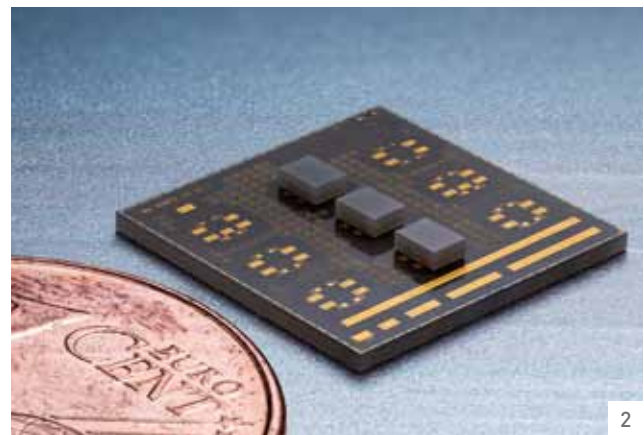

2 flip-chip mounted THz MMIC chips on AlN substrate

InP-Silicon Heterointegration: SciFab Foundry Process

The monolithic InP-silicon heterointegration using FBH's transferred substrate process is a key enabler for compact high-performance THz RF front-ends – this process is offered together with IHP as the SciFab foundry process. The wafer-level integration of InP-on-BiCMOS leads to a reduction in size, weight, and dissipated power as compared to existing assembly techniques. The SciFab library includes all necessary models and layout cells of transistors, capacitors, resistors, coils, interconnects, and line models for seamless circuit design and layout across the hetero-integrated technologies.

Flip-Chip Mounting

Shorter interconnection paths can be realized with flip-chip connections as compared to wire bonding. In addition, manufacturing control of placement and connection length in flip-chip assemblies is orders of magnitude better compared to wire bonding. Small-signal RF measurements of back-to-back flip-chip transitions fabricated at FBH show an insertion loss below 0.5 dB per interconnect and a return loss of more than 10 dB from DC up to 500 GHz. Flip-chip mounting thus offers a viable path for manufacturing low-cost mm-wave and THz assemblies.

Circuits & Detectors for THz Frequencies

The FBH provides an excellent environment in the field of high-speed electronic technologies, complex system-on-chip solutions, and characterization facilities. Building on its stand-alone and heterointegrated InP HBT high frequency technologies, FBH has developed application-specific MMICs, targeting in particular THz transmit and receive modules. Available building blocks include:

- oscillators up to 300GHz with measured output power > 0 dBm and good phase-noise properties
- VCO signal sources and multipliers up to 500GHz, full-band frequency multipliers at D- and G-band
- power amplifiers up to D-band with up to 100 mW output power

- W-band chipset including up/down converters, power amplifiers, and low-noise amplifiers
- novel approaches utilizing MMICs combined with BiCMOS in an InP-on-BiCMOS MMIC process (SciFab)

FBH has also developed integrated GaN HEMT plasmonic detectors and detector arrays for 0.5 – 4 THz for focal plane THz cameras and THz spectroscopy systems applications. These detectors exhibit state-of-the-art performance with record noise equivalent power (NEP) values.

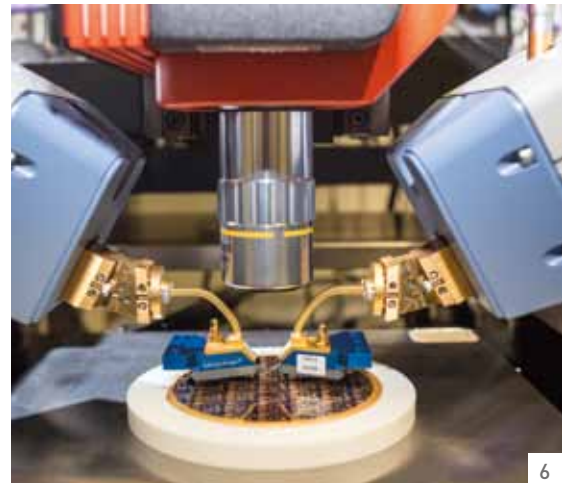
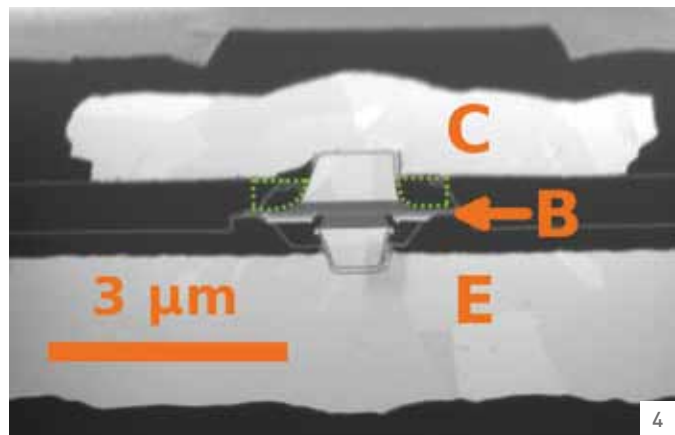
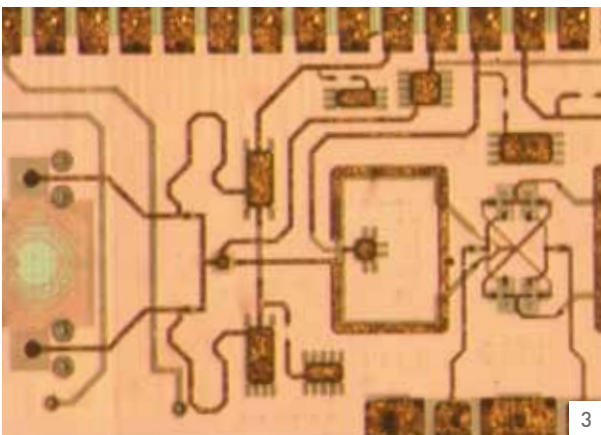

3 merging the best of two technology worlds – integrated InP-on-BiCMOS chip

4 cross section electron micrograph of 0.8µm heterointegrated InP HBT

5 THz-detector arrays for THz camera

6 on-wafer THz measurement setup

Measurements

FBH offers comprehensive electronic THz circuit characterization with small-signal and large-signal on-wafer measurement systems up to 500 GHz (to be extended to 1000 GHz):

- power and spectrum up to 750 GHz

- S-parameter measurements with precise semi-automatic probing (accuracy < 3µm) up to 500 GHz, which can map entire wafers without manual assistance
- on-wafer calibration hardware and software methodologies from W-band to 300 GHz – in cooperation with PTB, NPL, and industrial partners

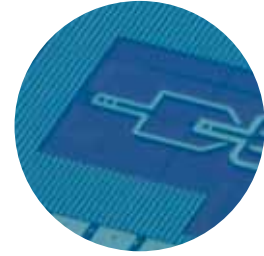
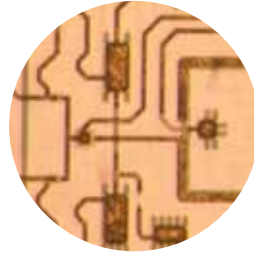
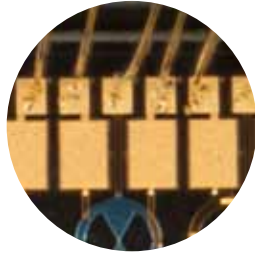

translating ideas into innovation

The Ferdinand-Braun-Institut, Leibniz-Institut fuer Hoehstfrequenztechnik (FBH) researches electronic and optical components, modules and systems based on compound semiconductors. These devices are key enablers that address the needs of today's society in fields like communications, energy, health, and mobility. Specifically, FBH develops light sources from the visible to the ultra-violet spectral range: high-power diode lasers with excellent beam quality, UV light sources, and hybrid laser modules. Applications range from medical technology, high-precision metrology and sensors to optical communications in space. In the field of microwaves, FBH develops high-efficiency multi-functional power amplifiers and millimeter-wave frontends targeting energy-efficient mobile communications, industrial sensing and imaging, as well as car safety systems. In addition, the institute fabricates laser drivers and compact atmospheric microwave plasma sources operating with economic low-voltage drivers for use in a variety of applications.

The FBH is an internationally recognized competence center for III-V compound semiconductors. It operates industry-compatible and flexible cleanroom laboratories with vapor phase epitaxy units and a III-V semiconductor process line. The work relies on comprehensive materials and process analysis equipment, a state-of-the-art device measurement environment, and excellent tools for simulation and CAD. In close cooperation with industry, its research results lead to cutting-edge products. To ensure Germany's technological competence in microwave and optoelectronic research, FBH works in strategic partnerships with industry. The institute also successfully turns innovative product ideas into spin-off companies.

contact

Ferdinand-Braun-Institut
Leibniz-Institut für Höchstfrequenztechnik
Gustav-Kirchhoff-Straße 4
12489 Berlin, Germany

www.fbh-berlin.de

InP Devices Lab

Dr. Nils Weimann
Phone +49 30 6392 2721
Fax +49 30 6392 2685
Email nils.weimann@fbh-berlin.de

Joint Lab Terahertz Electronics

Prof. Dr.-Ing. Viktor Krozer
Phone +49 30 6392 2789
Fax +49 30 6392 2685
Email viktor.krozer@fbh-berlin.de